



Prime Tools
& Solution e.U.
office@primetools.at

_AKTIONSZEITRAUM: 01.09 - 25.10.2024

TIGER-TEC® GOLD DREHSORTEN

WPP10G, WPP20G, WPP30G

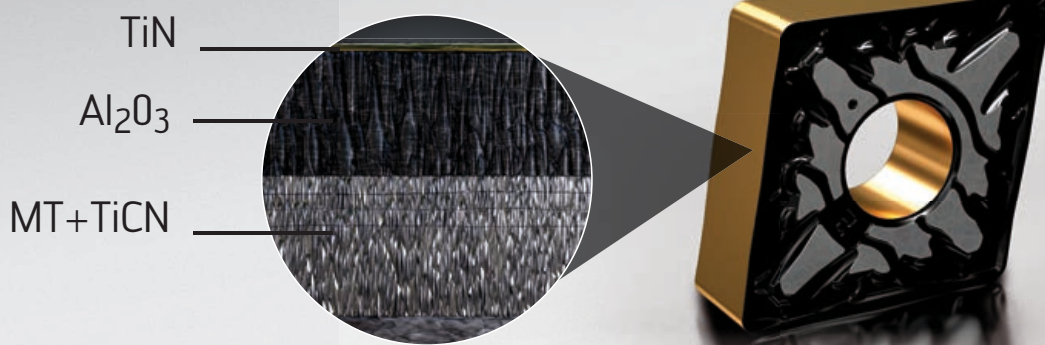

Kundenvorteil

60%



**TIGER-TEC® GOLD – STARK IN STAHL UND
GEGEN VERSCHLEISS.**

- Maximale Prozesssicherheit
- Hohe Flexibilität durch Benchmarkgeometrien
- + 50 % nachgewiesene Leistungssteigerung

 **WALTER**

Stark in Stahl und gegen Verschleiß.

DIE GEOMETRIE

- Negative Geometrien: FP5, MP3, MP5, MU5, RP5, RP7
- Positive Geometrien: FP4, MP4, RP4

DIE SORTE

- Neue Tiger-tec® Gold Beschichtung: feinkolumnares, hochtexturiertes MT-TiCN – widerstandsfähig gegen Freiflächenverschleiß
- Mehrlagige MT-TiCN-Struktur verbessert die elastische Eigenschaft der Kristalle
- Hochtexturiertes Al_2O_3 – für höheren Widerstand gegen Kolkverschleiß
- Mehrstufige Nachbehandlung für glatte Spanfläche, reduzierte Reibung und verbesserte Zähigkeit

DIE ANWENDUNG

WPP10G

- Verschleißfest bei kontinuierlichem Schnitt bis zu leichten Schnittunterbrechungen
- Hauptanwendung: Stahl ISO P10;
Nebenanwendung: Gusseisen ISO K20

WPP20G

- Universalsorte mit hoher Standzeit und Prozesssicherheit für ca. 50 % aller Einsatzfälle
- Hauptanwendung: Stahl ISO P20;
Nebenanwendung: Gusseisen ISO K30

WPP30G

- Zähle Sorte für Schnittunterbrechungen, instabile oder ungünstige Bedingungen
- Hauptanwendung: Stahl ISO P30;
Nebenanwendung: Gusseisen ISO K40 und nichtrostender Stahl ISO M20

Feinkolumnares, hochtexturiertes MT-TiCN – maximaler Widerstand gegen Freiflächenverschleiß



Hochtexturiertes Al_2O_3 – höherer Widerstand gegen Kolkverschleiß



Einzigartige, mehrlagige MT-TiCN – höhere Zähigkeit

Mehrstufige Nachbehandlung – glatte Spanfläche, reduzierte Reibung und verbesserte Zähigkeit

Tiger-tec®Gold

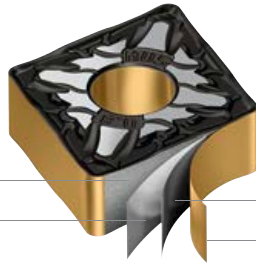

Hartmetall

MT-TiCN – hochtexturiert

Al₂O₃ – hochtexturiert

Gold-Toplayer

Abb.: Schichtaufbau TIG

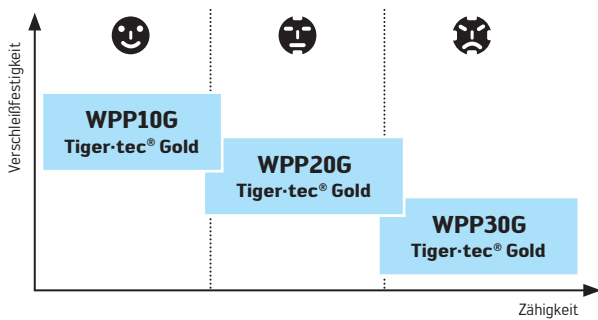

ANWENDUNGSBEISPIEL

Getriebewelle –
Innenbearbeitung Ø 29 mm

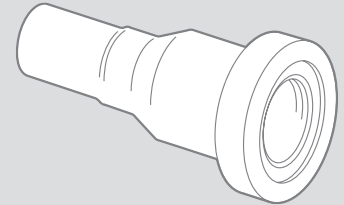

Werkstoff: 18MnCrS5 / DIN 1.8720

Festigkeit: 580 N/mm²

Werkzeug: E20S-SDUCR11-R

Wendeschneidplatte: DCMT11T304-FP4 WPP20G

Schnittdaten

	Wettbewerber ISO P20	Walter WPP20G Tiger-tec® Gold
v _c (m/min)	320	320
f (mm)	0,13	0,13
a _p (mm)	0,4	0,4
Kühlung	Emulsion 15 bar	Emulsion 15 bar
Standzeit (Stck.)	170	250

Vergleich: Standmenge

+ 47%

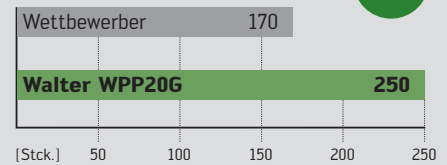

Konventionelles TiCN



Tiger-tec® Gold
MT-TiCN –
hochtexturiert



Hohe Verschleißfestigkeit
und Standzeitsteigerung

Tiger-tec® Gold

Al₂O₃ –
hochtexturiert

MT-TiCN –
hochtexturiert

Hartmetall

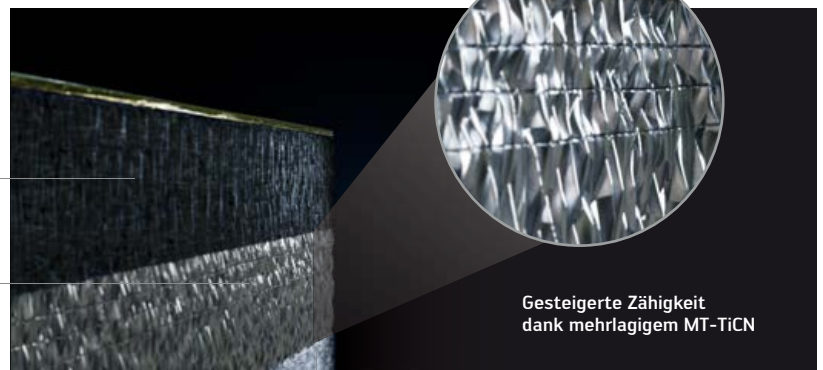

Gesteigerte Zähigkeit
dank mehrlagigem MT-TiCN

IHRE VORTEILE

- Hohe Produktivität und Prozesssicherheit dank mehrstufiger Nachbehandlung und einzigartiger, mehrlagiger MT-TiCN-Struktur
- Sorten und Benchmark-Geometrien für kurze Späne mit flexibler Einsetzbarkeit
- Hohe Wirtschaftlichkeit durch hochtexturierte Tiger-tec® Gold Beschichtung – durchschnittliche Standzeitsteigerung von rund 50 %

Bestellen Sie jetzt und nutzen Sie den Aktionsrabatt!



	P	M	K	N	S	H	O
WPP10G	●●	●	●	●	●	●	●
WPP20G	●●	●	●	●	●	●	●
WPP30G	●●	●	●	●	●	●	●

Wendeschneidplatte



FP5 - Finishing

Produktbeschreibung	r [mm]	f [mm]	a _p [mm]	SAP No.	Aktions-Preis	Bestellen
CNMG120404-FP5PDW WPP10G	0,4	0.04 - 0.20	0.1 - 1.5	8387369	€ 5,78	
CNMG120404-FP5PDW WPP20G	0,4	0.04 - 0.20	0.1 - 1.5	8388370	€ 5,78	
CNMG120408-FP5PDW WPP10G	0,8	0.08 - 0.25	0.2 - 2.0	8388371	€ 5,78	
CNMG120408-FP5PDW WPP20G	0,8	0.08 - 0.25	0.2 - 2.0	8388372	€ 5,78	
DNMG110404-FP5PDW WPP10G	0,4	0.04 - 0.20	0.1 - 1.5	8388373	€ 6,08	
DNMG110404-FP5PDW WPP20G	0,4	0.04 - 0.20	0.1 - 1.5	8388374	€ 6,08	
DNMG110408-FP5PDW WPP10G	0,8	0.08 - 0.25	0.2 - 2.0	8388375	€ 6,08	
DNMG110408-FP5PDW WPP20G	0,8	0.08 - 0.25	0.2 - 2.0	8388376	€ 6,08	
DNMG150404-FP5PDW WPP10G	0,4	0.05 - 0.20	0.1 - 1.5	8388377	€ 7,35	
DNMG150404-FP5PDW WPP20G	0,4	0.05 - 0.20	0.1 - 1.5	8388378	€ 7,35	
DNMG150408-FP5PDW WPP10G	0,8	0.08 - 0.25	0.2 - 2.0	8388379	€ 7,35	
DNMG150408-FP5PDW WPP20G	0,8	0.08 - 0.25	0.2 - 2.0	8388380	€ 7,35	
DNMG150604-FP5PDW WPP10G	0,4	0.05 - 0.20	0.1 - 1.5	8388381	€ 8,04	
DNMG150604-FP5PDW WPP20G	0,4	0.05 - 0.20	0.1 - 1.5	8388382	€ 8,04	
DNMG150608-FP5PDW WPP10G	0,8	0.08 - 0.25	0.2 - 2.0	8388383	€ 8,04	
DNMG150608-FP5PDW WPP20G	0,8	0.08 - 0.25	0.2 - 2.0	8388384	€ 8,04	
TNMG160404-FP5PDW WPP10G	0,4	0.04 - 0.20	0.1 - 1.5	8388385	€ 5,08	
TNMG160404-FP5PDW WPP20G	0,4	0.04 - 0.20	0.1 - 1.5	8388386	€ 5,08	
TNMG160408-FP5PDW WPP10G	0,8	0.08 - 0.25	0.2 - 2.0	8388387	€ 5,08	
TNMG160408-FP5PDW WPP20G	0,8	0.08 - 0.25	0.2 - 2.0	8388388	€ 5,08	
VNMG160404-FP5PDW WPP10G	0,4	0.04 - 0.22	0.1 - 1.5	8388389	€ 10,56	
VNMG160404-FP5PDW WPP20G	0,4	0.04 - 0.22	0.1 - 1.5	8388390	€ 10,56	
VNMG160408-FP5PDW WPP10G	0,8	0.08 - 0.25	0.2 - 2.0	8388391	€ 10,56	
VNMG160408-FP5PDW WPP20G	0,8	0.08 - 0.25	0.2 - 2.0	8388392	€ 10,56	
WNMG080404-FP5PDW WPP10G	0,4	0.05 - 0.20	0.1 - 1.5	8388393	€ 6,41	
WNMG080404-FP5PDW WPP20G	0,4	0.05 - 0.20	0.1 - 1.5	8388394	€ 6,41	
WNMG080408-FP5PDW WPP10G	0,8	0.08 - 0.25	0.2 - 2.0	8388395	€ 6,41	
WNMG080408-FP5PDW WPP20G	0,8	0.08 - 0.25	0.2 - 2.0	8388396	€ 6,41	

Absender

Firma

Name

Straße / Hausnr.

PLZ / Ort

Datum

Unterschrift

Nutzen Sie dieses Formular und bestellen Sie jetzt.

In Kooperation mit:



**Prime Tools
& Solution e.U.**
office@primetools.at

Bestellen Sie jetzt und nutzen Sie den Aktionsrabatt!



	P	M	K	N	S	H	O
WPP10G	●●	●	●	●	●	●	●
WPP20G	●●	●	●	●	●	●	●
WPP30G	●●	●	●	●	●	●	●

Wendeschneidplatte

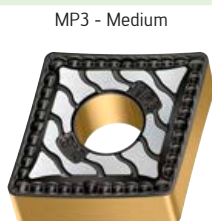

MP3 - Medium

Produktbeschreibung	r [mm]	f [mm]	a _p [mm]	SAP No.	Aktions-Preis	Bestellen
CNMG120404-MP3PDW WPP10G	0,4	0.08 - 0.22	0.3 - 2.5	8388397	€ 5,78	
CNMG120404-MP3PDW WPP20G	0,4	0.08 - 0.22	0.3 - 2.5	8388398	€ 5,78	
CNMG120408-MP3PDW WPP10G	0,8	0.12 - 0.32	0.6 - 3.2	8388399	€ 5,78	
CNMG120408-MP3PDW WPP20G	0,8	0.12 - 0.32	0.6 - 3.2	8388400	€ 5,78	
CNMG120412-MP3PDW WPP10G	1,2	0.16 - 0.40	0.8 - 3.5	8388401	€ 5,78	
CNMG120412-MP3PDW WPP20G	1,2	0.16 - 0.40	0.8 - 3.5	8388402	€ 5,78	
DNMG110404-MP3PDW WPP10G	0,4	0.08 - 0.22	0.3 - 2.2	8388403	€ 6,08	
DNMG110404-MP3PDW WPP20G	0,4	0.08 - 0.22	0.3 - 2.2	8388404	€ 6,08	
DNMG110408-MP3PDW WPP10G	0,8	0.12 - 0.32	0.6 - 3.0	8388405	€ 6,08	
DNMG110408-MP3PDW WPP20G	0,8	0.12 - 0.32	0.6 - 3.0	8388406	€ 6,08	
DNMG150604-MP3PDW WPP10G	0,4	0.08 - 0.22	0.3 - 2.5	8388407	€ 8,04	
DNMG150604-MP3PDW WPP20G	0,4	0.08 - 0.22	0.3 - 2.5	8388408	€ 8,04	
DNMG150608-MP3PDW WPP10G	0,8	0.12 - 0.32	0.6 - 3.2	8388409	€ 8,04	
DNMG150608-MP3PDW WPP20G	0,8	0.12 - 0.32	0.6 - 3.2	8388410	€ 8,04	
TNMG160404-MP3PDW WPP20G	0,4	0.08 - 0.22	0.3 - 2.2	8388411	€ 5,08	
TNMG160408-MP3PDW WPP10G	0,8	0.12 - 0.32	0.6 - 3.0	8388412	€ 5,08	
TNMG160408-MP3PDW WPP20G	0,8	0.12 - 0.32	0.6 - 3.0	8388413	€ 5,08	
VNMG160404-MP3PDW WPP10G	0,4	0.08 - 0.22	0.3 - 2.2	8388414	€ 10,56	
VNMG160404-MP3PDW WPP20G	0,4	0.08 - 0.22	0.3 - 2.2	8388415	€ 10,56	
VNMG160408-MP3PDW WPP10G	0,8	0.12 - 0.32	0.6 - 3.0	8388416	€ 10,56	
VNMG160408-MP3PDW WPP20G	0,8	0.12 - 0.32	0.6 - 3.0	8388417	€ 10,56	

Absender

Firma

Name

Straße / Hausnr.

PLZ / Ort

Datum

Unterschrift

Nutzen Sie dieses Formular und bestellen Sie jetzt.

In Kooperation mit:



Prime Tools
& Solution e.U.
office@primetools.at

Bestellen Sie jetzt und nutzen Sie den Aktionsrabatt!



	P	M	K	N	S	H	O
WPP10G	●●	●	●	●	●	●	●
WPP20G	●●	●	●	●	●	●	●
WPP30G	●●	●	●	●	●	●	●

Wendeschneidplatte

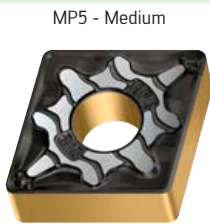

MP5 - Medium

Produktbeschreibung	r [mm]	f [mm]	a _p [mm]	SAP No.	Aktions-Preis	Bestellen
CNMG120404-MP5PDW WPP10G	0,4	0.16 - 0.25	0.5 - 4.0	8388418	€ 5,78	
CNMG120404-MP5PDW WPP20G	0,4	0.16 - 0.25	0.5 - 4.0	8388419	€ 5,78	
CNMG120408-MP5PDW WPP10G	0,8	0.18 - 0.40	0.6 - 5.0	8388420	€ 5,78	
CNMG120408-MP5PDW WPP20G	0,8	0.18 - 0.40	0.6 - 5.0	8388421	€ 5,78	
CNMG120408-MP5PDW WPP30G	0,8	0.18 - 0.40	0.6 - 5.0	8388422	€ 5,78	
CNMG120412-MP5PDW WPP10G	1,2	0.20 - 0.45	1.0 - 5.0	8388423	€ 5,78	
CNMG120412-MP5PDW WPP20G	1,2	0.20 - 0.45	1.0 - 5.0	8388424	€ 5,78	
CNMG120412-MP5PDW WPP30G	1,2	0.20 - 0.45	1.0 - 5.0	8388425	€ 5,78	
CNMG160608-MP5PDW WPP10G	0,8	0.25 - 0.40	0.8 - 7.0	8388426	€ 9,18	
CNMG160608-MP5PDW WPP20G	0,8	0.25 - 0.40	0.8 - 7.0	8388427	€ 9,18	
CNMG160612-MP5PDW WPP10G	1,2	0.30 - 0.50	1.0 - 7.0	8388428	€ 9,18	
CNMG160612-MP5PDW WPP20G	1,2	0.30 - 0.50	1.0 - 7.0	8388429	€ 9,18	
DNMG110408-MP5PDW WPP10G	0,8	0.18 - 0.35	0.6 - 4.0	8388430	€ 6,08	
DNMG110408-MP5PDW WPP20G	0,8	0.18 - 0.35	0.6 - 4.0	8388431	€ 6,08	
DNMG150408-MP5PDW WPP10G	0,8	0.18 - 0.35	0.6 - 5.0	8388432	€ 7,35	
DNMG150408-MP5PDW WPP20G	0,8	0.18 - 0.35	0.6 - 5.0	8388433	€ 7,35	
DNMG150604-MP5PDW WPP10G	0,4	0.16 - 0.25	0.5 - 4.0	8388434	€ 8,04	
DNMG150604-MP5PDW WPP20G	0,4	0.16 - 0.25	0.5 - 4.0	8388435	€ 8,04	
DNMG150608-MP5PDW WPP10G	0,8	0.18 - 0.35	0.6 - 5.0	8388436	€ 8,04	
DNMG150608-MP5PDW WPP20G	0,8	0.18 - 0.35	0.6 - 5.0	8388437	€ 8,04	
DNMG150612-MP5PDW WPP10G	1,2	0.20 - 0.40	1.0 - 5.0	8388438	€ 8,04	
DNMG150612-MP5PDW WPP20G	1,2	0.20 - 0.40	1.0 - 5.0	8388439	€ 8,04	
TNMG160404-MP5PDW WPP20G	0,4	0.16 - 0.25	0.5 - 4.0	8388440	€ 5,08	
TNMG160408-MP5PDW WPP10G	0,8	0.18 - 0.35	0.6 - 4.0	8388441	€ 5,08	
TNMG160408-MP5PDW WPP20G	0,8	0.18 - 0.35	0.6 - 4.0	8388442	€ 5,08	
VNMG160404-MP5PDW WPP20G	0,4	0.10 - 0.18	0.5 - 2.0	8388443	€ 10,56	
VNMG160408-MP5PDW WPP20G	0,8	0.18 - 0.35	0.6 - 4.0	8388444	€ 10,56	
WNMG080404-MP5PDW WPP10G	0,4	0.16 - 0.25	0.5 - 4.0	8388445	€ 6,41	
WNMG080404-MP5PDW WPP20G	0,4	0.16 - 0.25	0.5 - 4.0	8388446	€ 6,41	
WNMG080408-MP5PDW WPP10G	0,8	0.18 - 0.40	0.6 - 5.0	8388447	€ 6,41	
WNMG080408-MP5PDW WPP20G	0,8	0.18 - 0.40	0.6 - 5.0	8388448	€ 6,41	
WNMG080408-MP5PDW WPP30G	0,8	0.18 - 0.40	0.6 - 5.0	8388449	€ 6,41	
WNMG080412-MP5PDW WPP10G	1,2	0.20 - 0.45	1.0 - 5.0	8388450	€ 6,41	
WNMG080412-MP5PDW WPP20G	1,2	0.20 - 0.45	1.0 - 5.0	8388451	€ 6,41	
WNMG080412-MP5PDW WPP30G	1,2	0.20 - 0.45	1.0 - 5.0	8388452	€ 6,41	

Absender

Firma

Name

Straße / Hausnr.

PLZ / Ort

Datum

Unterschrift

Nutzen Sie dieses Formular und bestellen Sie jetzt.

In Kooperation mit:



**Prime Tools
& Solution e.U.**
office@primetools.at

Bestellen Sie jetzt und nutzen Sie den Aktionsrabatt!



	P	M	K	N	S	H	O
WPP10G	●●	●	●	●	●	●	●
WPP20G	●●	●	●	●	●	●	●
WPP30G	●●	●	●	●	●	●	●

Wendeschneidplatte

MU5 - Medium



Produktbeschreibung	r [mm]	f [mm]	a _p [mm]	SAP No.	Aktions-Preis	Bestellen
CNMG120408-MU5PDW WPP10G	0,8	0.15 - 0.40	0.6 - 5.0	8388453	€ 5,78	
CNMG120408-MU5PDW WPP20G	0,8	0.15 - 0.40	0.6 - 5.0	8388454	€ 5,78	
CNMG120412-MU5PDW WPP10G	1,2	0.20 - 0.50	1.0 - 5.0	8388455	€ 5,78	
CNMG120412-MU5PDW WPP20G	1,2	0.20 - 0.50	1.0 - 5.0	8388456	€ 5,78	
DNMG150608-MU5PDW WPP10G	0,8	0.18 - 0.35	0.6 - 5.0	8388457	€ 8,04	
DNMG150608-MU5PDW WPP20G	0,8	0.18 - 0.35	0.6 - 5.0	8388458	€ 8,04	
DNMG150612-MU5PDW WPP10G	1,2	0.20 - 0.45	1.0 - 5.0	8388459	€ 8,04	
DNMG150612-MU5PDW WPP20G	1,2	0.20 - 0.45	1.0 - 5.0	8388460	€ 8,04	
TNMG160404-MU5PDW WPP20G	0,4	0.15 - 0.30	0.5 - 4.0	8388461	€ 5,08	
TNMG160408-MU5PDW WPP20G	0,8	0.18 - 0.35	0.6 - 4.0	8388462	€ 5,08	
WNMG080408-MU5PDW WPP10G	0,8	0.15 - 0.40	0.6 - 5.0	8388463	€ 6,41	
WNMG080408-MU5PDW WPP20G	0,8	0.15 - 0.40	0.6 - 5.0	8388464	€ 6,41	
WNMG080412-MU5PDW WPP10G	1,2	0.20 - 0.50	1.0 - 5.0	8388465	€ 6,41	
WNMG080412-MU5PDW WPP20G	1,2	0.20 - 0.50	1.0 - 5.0	8388466	€ 6,41	

Absender

Firma

Name

Straße / Hausnr.

PLZ / Ort

Datum

Unterschrift

Nutzen Sie dieses Formular und bestellen Sie jetzt.

In Kooperation mit:



**Prime Tools
& Solution e.U.**
office@primetools.at

Bestellen Sie jetzt und nutzen Sie den Aktionsrabatt!

KUNDENVORTEIL
60%

	P	M	K	N	S	H	O
WPP10G	●●	●	●	●	●	●	●
WPP20G	●●	●	●	●	●	●	●
WPP30G	●●	●	●	●	●	●	●

Wendeschneidplatte



RP5 - Roughing

Produktbeschreibung	r [mm]	f [mm]	a _p [mm]	SAP No.	Aktions-Preis	Bestellen
CNMG120408-RP5PDW WPP10G	0,8	0.20 - 0.40	0.8 - 6.0	8388467	€ 5,78	
CNMG120408-RP5PDW WPP20G	0,8	0.20 - 0.40	0.8 - 6.0	8388468	€ 5,78	
CNMG120408-RP5PDW WPP30G	0,8	0.20 - 0.40	0.8 - 6.0	8388469	€ 5,78	
CNMG120412-RP5PDW WPP10G	1,2	0.25 - 0.60	1.0 - 6.0	8388470	€ 5,78	
CNMG120412-RP5PDW WPP20G	1,2	0.25 - 0.60	1.0 - 6.0	8388471	€ 5,78	
CNMG120412-RP5PDW WPP30G	1,2	0.25 - 0.60	1.0 - 6.0	8388472	€ 5,78	
CNMG160612-RP5PDW WPP10G	1,2	0.35 - 0.65	1.2 - 8.0	8388473	€ 9,18	
CNMG160612-RP5PDW WPP20G	1,2	0.35 - 0.65	1.2 - 8.0	8388474	€ 9,18	
CNMG160612-RP5PDW WPP30G	1,2	0.35 - 0.65	1.2 - 8.0	8388475	€ 9,18	
CNMG160616-RP5PDW WPP10G	1,6	0.40 - 0.70	1.6 - 8.0	8388476	€ 9,18	
CNMG160616-RP5PDW WPP20G	1,6	0.40 - 0.70	1.6 - 8.0	8388477	€ 9,18	
CNMG190612-RP5PDW WPP20G	1,2	0.30 - 0.70	1.2 - 10.	8386253	€ 12,84	
CNMG190612-RP5PDW WPP30G	1,2	0.30 - 0.70	1.2 - 10.	8386254	€ 12,84	
CNMG190616-RP5PDW WPP20G	1,6	0.35 - 0.80	1.6 - 10.	8386255	€ 12,84	
CNMG190616-RP5PDW WPP30G	1,6	0.35 - 0.80	1.6 - 10.	8386256	€ 12,84	
DNMG150608-RP5PDW WPP10G	0,8	0.15 - 0.35	0.8 - 5.0	8388478	€ 8,04	
DNMG150608-RP5PDW WPP20G	0,8	0.15 - 0.35	0.8 - 5.0	8388479	€ 8,04	
DNMG150608-RP5PDW WPP30G	0,8	0.15 - 0.35	0.8 - 5.0	8388480	€ 8,04	
DNMG150612-RP5PDW WPP10G	1,2	0.20 - 0.55	1.0 - 5.0	8388481	€ 8,04	
DNMG150612-RP5PDW WPP20G	1,2	0.20 - 0.55	1.0 - 5.0	8388482	€ 8,04	
WNMG080408-RP5PDW WPP10G	0,8	0.20 - 0.40	0.8 - 6.0	8388483	€ 6,41	
WNMG080408-RP5PDW WPP20G	0,8	0.20 - 0.40	0.8 - 6.0	8388484	€ 6,41	
WNMG080408-RP5PDW WPP30G	0,8	0.20 - 0.40	0.8 - 6.0	8388485	€ 6,41	
WNMG080412-RP5PDW WPP10G	1,2	0.25 - 0.60	1.0 - 6.0	8388486	€ 6,41	
WNMG080412-RP5PDW WPP20G	1,2	0.25 - 0.60	1.0 - 6.0	8388487	€ 6,41	
WNMG080412-RP5PDW WPP30G	1,2	0.25 - 0.60	1.0 - 6.0	8388488	€ 6,41	



RP7 - Roughing

CNMG120408-RP7PDW WPP10G	0,8	0.18 - 0.40	0.8 - 5.0	8388489	€ 5,78	
CNMG120408-RP7PDW WPP20G	0,8	0.18 - 0.40	0.8 - 5.0	8388490	€ 5,78	
CNMG120408-RP7PDW WPP30G	0,8	0.18 - 0.40	0.8 - 5.0	8388491	€ 5,78	
CNMG120412-RP7PDW WPP10G	1,2	0.25 - 0.50	1.2 - 5.0	8388492	€ 5,78	
CNMG120412-RP7PDW WPP20G	1,2	0.25 - 0.50	1.2 - 5.0	8388493	€ 5,78	
CNMG120412-RP7PDW WPP30G	1,2	0.25 - 0.50	1.2 - 5.0	8388494	€ 5,78	
CNMG160612-RP7PDW WPP10G	1,2	0.35 - 0.60	1.2 - 6.0	8388495	€ 9,18	
CNMG160612-RP7PDW WPP20G	1,2	0.35 - 0.60	1.2 - 6.0	8388496	€ 9,18	
CNMG160612-RP7PDW WPP30G	1,2	0.35 - 0.60	1.2 - 6.0	8388497	€ 9,18	

Absender

Firma

Name

Straße / Hausnr.

PLZ / Ort

Datum

Unterschrift

Nutzen Sie dieses Formular und bestellen Sie jetzt.

In Kooperation mit:



Prime Tools
& Solution e.U.
office@primetools.at

Bestellen Sie jetzt und nutzen Sie den Aktionsrabatt!



	P	M	K	N	S	H	O
WPP10G	●●	●	●	●	●	●	●
WPP20G	●●	●	●	●	●	●	●
WPP30G	●●	●	●	●	●	●	●

Wendeschneidplatte

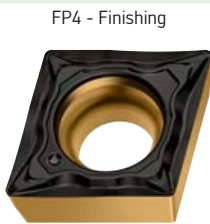

FP4 - Finishing

Produktbeschreibung	r [mm]	f [mm]	a _p [mm]	SAP No.	Aktions-Preis	Bestellen
CCMT060202-FP4PDW WPP10G	0,2	0.04 - 0.12	0.1 - 1.0	8387652	€ 4,00	
CCMT060202-FP4PDW WPP20G	0,2	0.04 - 0.12	0.1 - 1.0	8387653	€ 4,00	
CCMT060204-FP4PDW WPP10G	0,4	0.05 - 0.16	0.1 - 1.5	8387655	€ 4,00	
CCMT060204-FP4PDW WPP20G	0,4	0.05 - 0.16	0.1 - 1.5	8387654	€ 4,00	
CCMT09T304-FP4PDW WPP10G	0,4	0.05 - 0.16	0.1 - 1.5	8387664	€ 4,66	
CCMT09T304-FP4PDW WPP20G	0,4	0.05 - 0.16	0.1 - 1.5	8387663	€ 4,66	
CCMT09T308-FP4PDW WPP10G	0,8	0.08 - 0.20	0.1 - 1.5	8387670	€ 4,66	
CCMT09T308-FP4PDW WPP20G	0,8	0.08 - 0.20	0.1 - 1.5	8387669	€ 4,66	
DCMT070204-FP4PDW WPP10G	0,4	0.05 - 0.16	0.1 - 1.5	8387682	€ 3,98	
DCMT070204-FP4PDW WPP20G	0,4	0.05 - 0.16	0.1 - 1.5	8387681	€ 3,98	
DCMT11T302-FP4PDW WPP10G	0,2	0.04 - 0.12	0.1 - 1.0	8387684	€ 5,56	
DCMT11T302-FP4PDW WPP20G	0,2	0.04 - 0.12	0.1 - 1.0	8387683	€ 5,56	
DCMT11T304-FP4PDW WPP10G	0,4	0.05 - 0.16	0.1 - 1.5	8387685	€ 5,56	
DCMT11T304-FP4PDW WPP20G	0,4	0.05 - 0.16	0.1 - 1.5	8387650	€ 5,56	
DCMT11T308-FP4PDW WPP10G	0,8	0.08 - 0.20	0.1 - 1.5	8387691	€ 5,56	
DCMT11T308-FP4PDW WPP20G	0,8	0.08 - 0.20	0.1 - 1.5	8387692	€ 5,56	
TCMT06T102-FP4PDW WPP20G	0,2	0.02 - 0.10	0.1 - 1.0	8387715	€ 4,04	
TCMT06T104-FP4PDW WPP20G	0,4	0.04 - 0.17	0.1 - 1.0	8387716	€ 4,04	
TCMT110202-FP4PDW WPP20G	0,2	0.04 - 0.12	0.1 - 1.0	8387717	€ 4,42	
TCMT110204-FP4PDW WPP10G	0,4	0.05 - 0.16	0.1 - 1.5	8387718	€ 4,42	
TCMT110204-FP4PDW WPP20G	0,4	0.05 - 0.16	0.1 - 1.5	8387719	€ 4,42	
VCMT110302-FP4PDW WPP20G	0,2	0.04 - 0.12	0.1 - 1.0	8387702	€ 6,74	
VCMT110304-FP4PDW WPP10G	0,4	0.05 - 0.16	0.1 - 1.5	8387703	€ 6,74	
VCMT110304-FP4PDW WPP20G	0,4	0.05 - 0.16	0.1 - 1.5	8387704	€ 6,74	
VCMT160402-FP4PDW WPP20G	0,2	0.04 - 0.12	0.1 - 1.0	8387707	€ 7,76	
VCMT160404-FP4PDW WPP10G	0,4	0.05 - 0.16	0.1 - 1.5	8387709	€ 7,76	
VCMT160404-FP4PDW WPP20G	0,4	0.05 - 0.16	0.1 - 1.5	8387708	€ 7,76	
VCMT160408-FP4PDW WPP10G	0,8	0.08 - 0.20	0.1 - 1.5	8387712	€ 7,76	
VCMT160408-FP4PDW WPP20G	0,8	0.08 - 0.20	0.1 - 1.5	8387651	€ 7,76	

Absender

Firma

Name

Straße / Hausnr.

PLZ / Ort

Datum

Unterschrift

Nutzen Sie dieses Formular und bestellen Sie jetzt.

In Kooperation mit:



**Prime Tools
& Solution e.U.**
office@primetools.at

Bestellen Sie jetzt und nutzen Sie den Aktionsrabatt!



	P	M	K	N	S	H	O
WPP10G	●●	●	●	●	●	●	●
WPP20G	●●	●	●	●	●	●	●
WPP30G	●●	●	●	●	●	●	●

Wendeschneidplatte

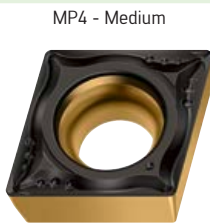

MP4 - Medium

Produktbeschreibung	r [mm]	f [mm]	a _p [mm]	SAP No.	Aktions-Preis	Bestellen
CCMT060204-MP4PDW WPP10G	0,4	0.08 - 0.20	0.4 - 2.0	8387657	€ 4,00	
CCMT060204-MP4PDW WPP20G	0,4	0.08 - 0.20	0.4 - 2.0	8387656	€ 4,00	
CCMT060208-MP4PDW WPP20G	0,8	0.12 - 0.25	0.5 - 2.0	8387660	€ 4,00	
CCMT09T304-MP4PDW WPP10G	0,4	0.08 - 0.25	0.4 - 3.0	8387666	€ 4,66	
CCMT09T304-MP4PDW WPP20G	0,4	0.08 - 0.25	0.4 - 3.0	8387665	€ 4,66	
CCMT09T308-MP4PDW WPP10G	0,8	0.12 - 0.32	0.5 - 3.0	8387671	€ 4,66	
CCMT09T308-MP4PDW WPP20G	0,8	0.12 - 0.32	0.5 - 3.0	8386258	€ 4,66	
CCMT120404-MP4PDW WPP20G	0,4	0.12 - 0.25	0.4 - 3.5	8387675	€ 6,66	
CCMT120408-MP4PDW WPP20G	0,8	0.12 - 0.32	0.5 - 3.5	8387678	€ 6,66	
DCMT11T304-MP4PDW WPP10G	0,4	0.08 - 0.25	0.4 - 3.0	8387687	€ 5,56	
DCMT11T304-MP4PDW WPP20G	0,4	0.08 - 0.25	0.4 - 3.0	8387686	€ 5,56	
DCMT11T308-MP4PDW WPP10G	0,8	0.12 - 0.32	0.5 - 3.0	8387694	€ 5,56	
DCMT11T308-MP4PDW WPP20G	0,8	0.12 - 0.32	0.5 - 3.0	8387693	€ 5,56	
TCMT110204-MP4PDW WPP20G	0,4	0.08 - 0.20	0.4 - 2.0	8387720	€ 4,42	
TCMT16T304-MP4PDW WPP20G	0,4	0.08 - 0.25	0.4 - 3.0	8387721	€ 5,74	
TCMT16T308-MP4PDW WPP20G	0,8	0.12 - 0.32	0.5 - 3.0	8387724	€ 5,74	
VBMT160404-MP4PDW WPP10G	0,4	0.08 - 0.20	0.4 - 2.0	8387699	€ 7,76	
VBMT160404-MP4PDW WPP20G	0,4	0.08 - 0.20	0.4 - 2.0	8387698	€ 7,76	
VBMT160408-MP4PDW WPP10G	0,8	0.12 - 0.30	0.5 - 2.0	8387700	€ 7,76	
VBMT160408-MP4PDW WPP20G	0,8	0.12 - 0.30	0.5 - 2.0	8387701	€ 7,76	

Absender

Firma

Name

Straße / Hausnr.

PLZ / Ort

Datum

Unterschrift

Nutzen Sie dieses Formular und bestellen Sie jetzt.

In Kooperation mit:



Prime Tools
 & Solution e.U.
 office@primetools.at

Bestellen Sie jetzt und nutzen Sie den Aktionsrabatt!



	P	M	K	N	S	H	O
WPP10G	●●	●	●	●	●	●	●
WPP20G	●●	●	●	●	●	●	●
WPP30G	●●	●	●	●	●	●	●

Wendeschneidplatte

RP4 - Roughing

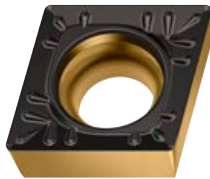

Produktbeschreibung	r [mm]	f [mm]	a _p [mm]	SAP No.	Aktions-Preis	Bestellen
CCMT060204-RP4PDW WPP20G	0,4	0.12 - 0.25	0.4 - 2.5	8387658	€ 4,00	
CCMT060204-RP4PDW WPP30G	0,4	0.12 - 0.25	0.4 - 2.5	8387659	€ 4,00	
CCMT060208-RP4PDW WPP20G	0,8	0.16 - 0.30	0.6 - 2.5	8387662	€ 4,00	
CCMT060208-RP4PDW WPP30G	0,8	0.16 - 0.30	0.6 - 2.5	8387661	€ 4,00	
CCMT09T304-RP4PDW WPP10G	0,4	0.12 - 0.25	0.4 - 3.0	8387668	€ 4,66	
CCMT09T304-RP4PDW WPP20G	0,4	0.12 - 0.25	0.4 - 3.0	8387667	€ 4,66	
CCMT09T304-RP4PDW WPP30G	0,4	0.12 - 0.25	0.4 - 3.0	8386257	€ 4,66	
CCMT09T308-RP4PDW WPP10G	0,8	0.16 - 0.35	0.6 - 4.0	8387674	€ 4,66	
CCMT09T308-RP4PDW WPP20G	0,8	0.16 - 0.35	0.6 - 4.0	8387673	€ 4,66	
CCMT09T308-RP4PDW WPP30G	0,8	0.16 - 0.35	0.6 - 4.0	8387672	€ 4,66	
CCMT120404-RP4PDW WPP20G	0,4	0.12 - 0.30	0.4 - 4.0	8387677	€ 6,66	
CCMT120404-RP4PDW WPP30G	0,4	0.12 - 0.30	0.4 - 4.0	8387676	€ 6,66	
CCMT120408-RP4PDW WPP10G	0,8	0.16 - 0.40	0.6 - 5.0	8387680	€ 6,66	
CCMT120408-RP4PDW WPP20G	0,8	0.16 - 0.40	0.6 - 5.0	8386259	€ 6,66	
CCMT120408-RP4PDW WPP30G	0,8	0.16 - 0.40	0.6 - 5.0	8387679	€ 6,66	
DCMT11T304-RP4PDW WPP10G	0,4	0.12 - 0.25	0.4 - 3.0	8387690	€ 5,56	
DCMT11T304-RP4PDW WPP20G	0,4	0.12 - 0.25	0.4 - 3.0	8387688	€ 5,56	
DCMT11T304-RP4PDW WPP30G	0,4	0.12 - 0.25	0.4 - 3.0	8387689	€ 5,56	
DCMT11T308-RP4PDW WPP10G	0,8	0.16 - 0.35	0.6 - 4.0	8387697	€ 5,56	
DCMT11T308-RP4PDW WPP20G	0,8	0.16 - 0.35	0.6 - 4.0	8387695	€ 5,56	
DCMT11T308-RP4PDW WPP30G	0,8	0.16 - 0.35	0.6 - 4.0	8387696	€ 5,56	
SCMT09T304-RP4PDW WPP20G	0,4	0.12 - 0.25	0.4 - 3.0	8387727	€ 4,66	
SCMT09T304-RP4PDW WPP30G	0,4	0.12 - 0.25	0.4 - 3.0	8387728	€ 4,66	
SCMT09T308-RP4PDW WPP20G	0,8	0.16 - 0.35	0.6 - 4.0	8387729	€ 4,66	
SCMT09T308-RP4PDW WPP30G	0,8	0.16 - 0.35	0.6 - 4.0	8387730	€ 4,66	
SCMT120408-RP4PDW WPP20G	0,8	0.16 - 0.40	0.6 - 5.0	8387731	€ 6,66	
SCMT120408-RP4PDW WPP30G	0,8	0.16 - 0.40	0.6 - 5.0	8387732	€ 6,66	
TCMT16T304-RP4PDW WPP20G	0,4	0.12 - 0.25	0.4 - 3.0	8387722	€ 5,74	
TCMT16T304-RP4PDW WPP30G	0,4	0.12 - 0.25	0.4 - 3.0	8387723	€ 5,74	
TCMT16T308-RP4PDW WPP20G	0,8	0.16 - 0.35	0.6 - 4.0	8387725	€ 5,74	
TCMT16T308-RP4PDW WPP30G	0,8	0.16 - 0.35	0.6 - 4.0	8387726	€ 5,74	
VCMT110304-RP4PDW WPP20G	0,4	0.12 - 0.20	0.4 - 2.5	8387705	€ 6,74	
VCMT110308-RP4PDW WPP20G	0,8	0.16 - 0.25	0.6 - 3.0	8387706	€ 6,74	
VCMT160404-RP4PDW WPP10G	0,4	0.12 - 0.25	0.4 - 2.5	8387711	€ 7,76	
VCMT160404-RP4PDW WPP20G	0,4	0.12 - 0.25	0.4 - 2.5	8387710	€ 7,76	
VCMT160408-RP4PDW WPP10G	0,8	0.16 - 0.30	0.6 - 3.0	8387713	€ 7,76	
VCMT160408-RP4PDW WPP20G	0,8	0.16 - 0.30	0.6 - 3.0	8387714	€ 7,76	

Absender

Firma

Name

Straße / Hausnr.

PLZ / Ort

Datum

Unterschrift

Nutzen Sie dieses Formular und bestellen Sie jetzt.

In Kooperation mit:



**Prime Tools
& Solution e.U.**
office@primetools.at



Prime Tools
& Solution e.U.
office@primetools.at

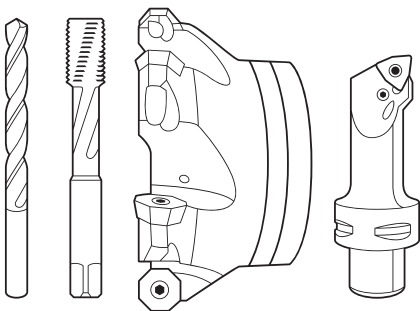

www.walter-tools.com